

Kondenzační jednotka UUB1 U20

[Unit: mm]

Chassis code : U24A
DWG No. : TBW35646501_Rev01

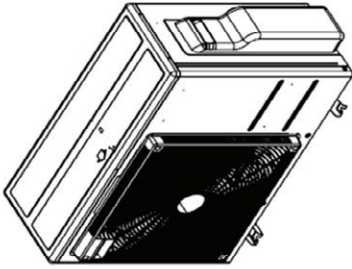

3D View

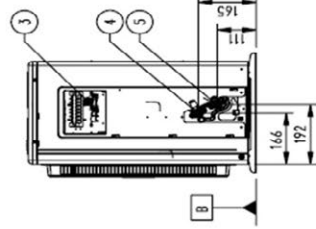
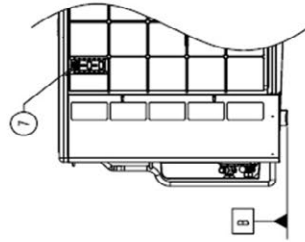

Side View
(removed valve cover)

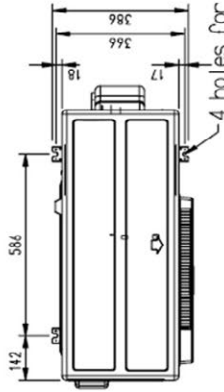
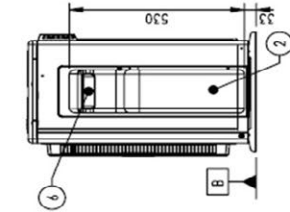

4 holes for Anchor Bolts (M10)

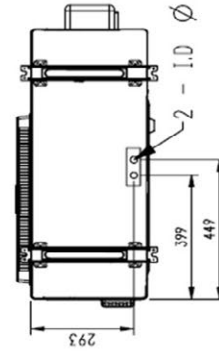
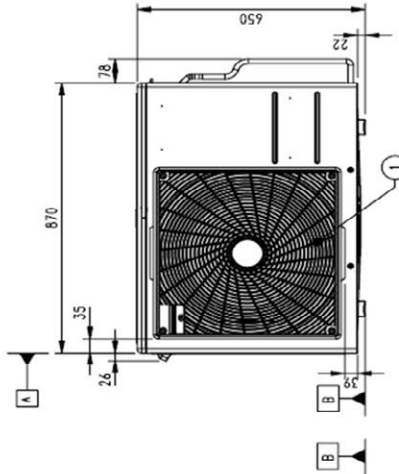

2 - 1.0 Ø 20 Holes for drain connection

1. Unit should be installed in compliance with the installation manual in the product box
2. Unit should be grounded in accordance with the local regulations or applicable national codes
3. All electrical components and materials to be supplied from the site must comply with the local regulations or international codes
4. Electrical characteristics chapter should be considered for electrical work and design. Especially the power cable and circuit breaker should be selected in accordance with that

No.	Part Name	Description
7	Intake air temperature sensor cover	-
6	Handle	-
5	Liquid Pipe connection	-
4	Gas Pipe Connection	-
3	Power and communication cable connection	-
2	Control cover & SVC valve cover	-
1	Air Outlet	-